

# Taymor®

## 1900 SERIES POWER ADJUSTABLE DOOR CLOSERS

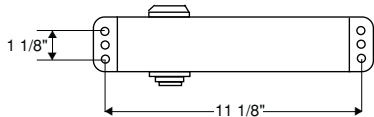

ADA COMPLIANT  
BARRIER FREE  
SELECTED ITEMS



DOOR CLOSERS

**MEETS ULIOC, UBC-7-2 AND ADA REQUIREMENTS**

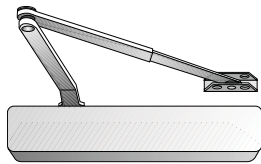

**"UNIVERSAL"  
MOUNTING**

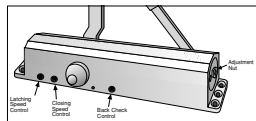

### FEATURES

- ◆ UL LISTED
- ◆ 10 YEAR GUARANTEE
- ◆ POWER ADJUSTABLE
- ◆ STANDARD AND MEDIUM DUTY COMMERCIAL APPLICATION
- ◆ ADJUSTABLE BACK CHECK STANDARD
- ◆ UNIVERSAL MOUNTING (REGULAR AND PARALLEL BRACKETS INCLUDED)
- ◆ HIGH STRENGTH PRESSURE CAST ALUMINUM HOUSING
- ◆ FULL COVER
- ◆ OPTIONAL DELAYED ACTION
- ◆ DUAL VALVE ADJUSTABLE
- ◆ PROJECTION – NARROW PROFILE (27/16" FROM DOOR)
- ◆ NON-HANDED – REVERSIBLE
- ◆ FULL RACK AND PINION MECHANISM
- ◆ LEAK PROOF "O" RINGS OIL SEAL

**IMPORTANT:** FACTORY PRESET – SIZE 3 (CLOCKWISE ADJUSTMENT INCREASES POWER – ANTICLOCKWISE DECREASES POWER)

**CONFORMS TO POSITIVE PRESSURE – STANDARDS ULIOC AND UBC7-2 (1977)**

DESCRIPTION	FINISH	MODEL #	CASE QTY.
<b>ADJUSTABLE POWER 2 THROUGH 6 WITH BACKCHECK</b> MAXIMUM DOOR SIZE: 48" x 96" MAXIMUM DOOR WEIGHT: 266 LBS	ALUMINUM	13-1900AL	6
	DURONODIC BRONZE	13-1900DB	6
	POLISHED BRASS	13-1900PB	6
<b>ADJUSTABLE POWER 1 THROUGH 4 WITH BACKCHECK &amp; BARRIER FREE</b> MAXIMUM DOOR SIZE: 42" x 96" MAXIMUM DOOR WEIGHT: 188 LBS 	ALUMINUM	13-1900BFAL	6
	DURONODIC BRONZE	13-1900BFDB	6
	POLISHED BRASS	13-1900BFPB	6
<b>ADJUSTABLE POWER 1 THROUGH 4 WITH BACKCHECK, BARRIER FREE &amp; DELAYED ACTION</b> MAXIMUM EXTERIOR DOOR SIZE: 42" x 96" MAXIMUM INTERIOR DOOR SIZE: 48" x 84" MAX. DOOR WEIGHT: 188 LBS 	ALUMINUM	13-1900BFDAAL	6
	DURONODIC BRONZE	13-1900BFDADB	6
	POLISHED BRASS	13-1900BFDAPB	6

**Taymor®**

**800 SERIES  
POWER  
ADJUSTABLE**

**DOOR CLOSERS**



ADA COMPLIANT  
BARRIER FREE  
SELECTED ITEMS



WITHOUT COVER

**FEATURES**

- ◆ UL LISTED
- ◆ 5 YEAR GUARANTEE
- ◆ POWER ADJUSTABLE
- ◆ BACKCHECK FUNCTION IS STANDARD
- ◆ STANDARD AND MEDIUM DUTY COMMERCIAL APPLICATION
- ◆ UNIVERSAL MOUNTING (REGULAR AND PARALLEL BRACKETS INCLUDED)
- ◆ HIGH STRENGTH PRESSURE CAST ALUMINUM HOUSING
- ◆ DUAL VALVE ADJUSTABLE CLOSING AND LATCHING SPEED
- ◆ NON-HANDED – REVERSIBLE
- ◆ FULL RACK AND PINION MECHANISM
- ◆ LEAK PROOF “O” RINGS OIL SEAL
- ◆ ATTRACTIVE PLASTIC COVER SUPPLIED – STANDARD

**IMPORTANT:** FACTORY PRESET – SIZE 3 (CLOCKWISE ADJUSTMENT INCREASES POWER – ANTI-CLOCKWISE DECREASES POWER)

DESCRIPTION	FINISH	MODEL #	CASE QTY.
STANDARD MODEL ADJUSTABLE POWER 2 THROUGH 5 WITH PLASTIC COVER MAXIMUM DOOR SIZE: 48" x 96" MAXIMUM DOOR WEIGHT: 240 LBS	ALUMINUM	14-800AL	6
	DURONODIC BRONZE	14-800DB	6
BARRIER FREE MODEL ADJUSTABLE POWER 1 THROUGH 4 WITH PLASTIC COVER MAXIMUM DOOR SIZE: 42" x 96" MAXIMUM DOOR WEIGHT: 188 LBS	ALUMINUM	14-800BFAL	6
	DURONODIC BRONZE	14-800BFDB	6



# Taymor®

## 690 SERIES BACKCHECK

### DOOR CLOSERS

#### FEATURES

- ◆ UL LISTED
- ◆ 3 VALVES
- ◆ THROUGH BOLTS INCLUDED
- ◆ STANDARD SHOE AND PARALLEL BRACKETS INCLUDED FOR UNIVERSAL INSTALLATION
- ◆ WIND CONDITIONS AND PRESSURE DIFFERENTIALS REQUIRE LARGER POWER SIZE. FOR UNUSUAL CONDITIONS MOVE UP ONE SIZE CLOSER OR CONSULT YOUR TAYMOR REPRESENTATIVE
- ◆ 5 YEAR GUARANTEE
- ◆ ADJUSTABLE BACK CHECK

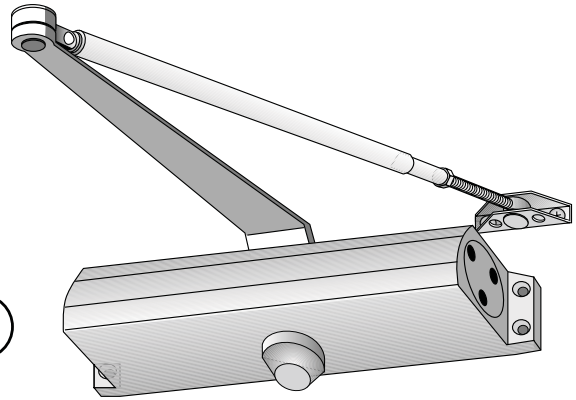

DOOR CLOSERS

TURN BACKCHECK VALVE CLOCKWISE FOR A WEAKER BACKCHECK FUNCTION.

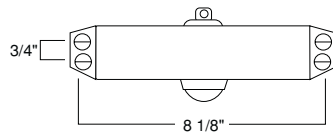

**SIZE 3**

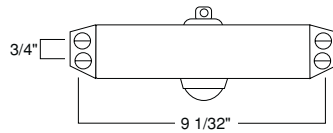

**SIZE 4**

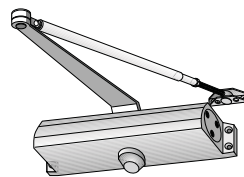

**STANDARD MOUNT**

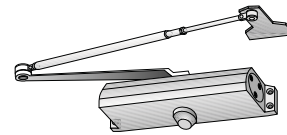

**PARALLEL MOUNT**

DESCRIPTION	FINISH	MODEL #	CASE QTY.
<b>690 SERIES DOOR CLOSER SIZE 3</b> MAXIMUM DOOR SIZE: 36" x 84" MAXIMUM DOOR WEIGHT: 88 – 143 LBS	ALUMINUM	14-693AL	10
	DURONODIC BRONZE	14-693DB	10
<b>690 SERIES DOOR CLOSER SIZE 4</b> MAXIMUM DOOR SIZE: 36" x 108" MAXIMUM DOOR WEIGHT: 132 – 187 LBS	ALUMINUM	14-694AL	10
	DURONODIC BRONZE	14-694DB	10

# Taymor®

## 600 SERIES

### DOOR CLOSERS

#### FEATURES

- ◆ UL LISTED
- ◆ 5 YEAR GUARANTEE
- ◆ DUAL VALVE
- ◆ STANDARD SHOE AND PARALLEL BRACKETS INCLUDED
- ◆ ALLOWS FOR UNIVERSAL INSTALLATION
- ◆ THROUGH BOLTS INCLUDED
- ◆ WIND CONDITIONS AND PRESSURE DIFFERENTIALS REQUIRE LARGER POWER SIZE. FOR UNUSUAL CONDITIONS MOVE UP ONE SIZE CLOSER OR CONSULT YOUR TAYMOR REPRESENTATIVE

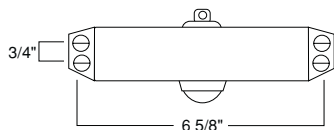

SIZE 2

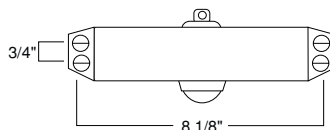

SIZE 3

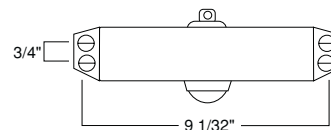

SIZE 4

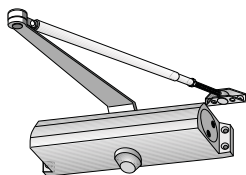

STANDARD MOUNT

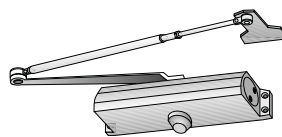

PARALLEL MOUNT

DESCRIPTION	FINISH	MODEL #	CASE QTY.
600 SERIES DOOR CLOSER SIZE 2 MAXIMUM DOOR SIZE: 36" x 84" MAXIMUM DOOR WEIGHT: 45 – 100 LBS	ALUMINUM	14-602AL	10
	ENAMELLED BRASS	14-602BR	10
	DURONODIC BRONZE	14-602DB	10
	WHITE	14-602W	10
600 SERIES DOOR CLOSER SIZE 3 MAXIMUM DOOR SIZE: 36" x 84" MAXIMUM DOOR WEIGHT: 88 – 143 LBS	ALUMINUM	14-603AL	10
	ENAMELLED BRASS	14-603BR	10
	DURONODIC BRONZE	14-603DB	10
	WHITE	14-603W	10
600 SERIES DOOR CLOSER SIZE 4 MAXIMUM DOOR SIZE: 36" x 108" MAXIMUM DOOR WEIGHT: 132 – 187 LBS	ALUMINUM	14-604AL	10
	ENAMELLED BRASS	14-604BR	10
	DURONODIC BRONZE	14-604DB	10
	WHITE	14-604W	10

# Taymor®

## HOTEL/MOTEL DOOR CLOSER

### FEATURES

- ◆ UL LISTED
- ◆ 5 YEAR GUARANTEE
- ◆ IDEAL FOR GUEST ROOMS
- ◆ ADJUSTABLE DELAYED ACTION FUNCTION THROUGH SEPARATE VALVE
- ◆ THREE SEPARATE REGULATING VALVES TO CONTROL CLOSING AND LATCHING SPEEDS AND DELAYED ACTION FUNCTION
- ◆ REVERSIBLE FOR BOTH RIGHT AND LEFT HAND DOORS
- ◆ HIGH STRENGTH PRESSURE CAST ALUMINUM HOUSING
- ◆ FULL RACK AND PINION MECHANISM
- ◆ HEAT TREATED HIGH TENSILE ONE PIECE PISTON AND SPINDLE
- ◆ LEAK PROOF "O" RINGS OIL SEAL
- ◆ HIGH LUBRICITY AND LOW POUR POINT HIGH QUALITY HYDRAULIC FLUID
- ◆ ADJUSTABLE ARM FOR ALL MODELS
- ◆ VERSATILE AND EASY INSTALLATION



THE DELAYED ACTION VALVE ALLOWS FOR EASY ENTRY/EXIT WHEN LUGGAGE IS BEING CARRIED IN OR OUT OF DOORWAY

DOOR CLOSERS

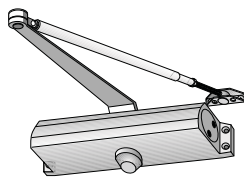
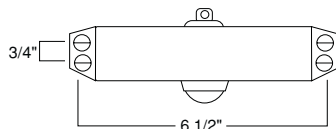

STANDARD MOUNT

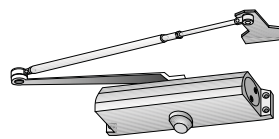

PARALLEL MOUNT

MODEL #	FINISH	MAXIMUM REC. DOOR SIZE	MAXIMUM REC. DOOR WEIGHT	CASE QTY.
<b>STANDARD</b>				
13-DA703AAL (REGULAR ARM)	ALUMINUM	38" x 84"	88 – 144 LBS	10
13-DA703PAL (PARALLEL ARM)	ALUMINUM	38" x 84"	88 – 144 LBS	10
<b>WITH PLASTIC COVER</b>				
13-CDA703AAL (REGULAR ARM)	ALUMINUM (PLASTIC COVER)	38" x 84"	88 – 144 LBS	10
13-CDA703PAL (PARALLEL ARM)	ALUMINUM (PLASTIC COVER)	38" x 84"	88 – 144 LBS	10

**Taymor®**

**ACCESSORIES**

**F O R D O O R C L O S E R S**

**1 9 0 0 S E R I E S**

ILLUSTRATION	DESCRIPTION	FINISH	MODEL #	CASE QTY.
--------------	-------------	--------	---------	-----------

**FLAT DROP BRACKET FOR 1900 SERIES**  
 FOR USE WHEN TOP DOOR RAIL OR TOP JAMB PROVIDES INSUFFICIENT  
 SUPPORT OR IS TOO NARROW TO MOUNT CLOSER.

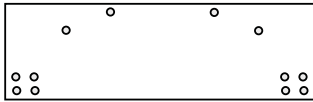

TO SUIT CLOSER MODEL  
 13-1900

ALUMINUM  
 DURONODIC BRONZE  
 BRASS (US3)

13-697AL 10  
 13-697DB 10  
 13-697PB 10

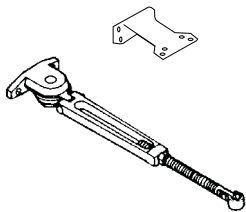

**HOLD OPEN FOR 1900  
 DOOR CLOSER**

ALUMINUM

13-HOR1900 10





## ACCESSORIES

FOR DOOR CLOSERS

600 & 693 SERIES

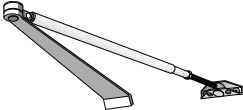
### FEATURES

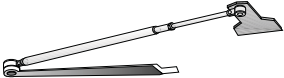
- ◆ INCLUDES THE FOREARM AND EITHER THE REGULAR ARM OR THE PARALLEL ARM BRACKETS

ILLUSTRATION	DESCRIPTION	FINISH	MODEL #	CASE QTY.
	<b>A-TYPE REPLACEMENT ARM</b> FOR CLOSER MODEL 602	ALUMINUM	14-R602AAL	10
		DURONODIC BRONZE	14-R602ADB	10
		BRASS (US3)	14-R602ABR	10
		WHITE	14-R602AWH	10
	<b>A-TYPE REPLACEMENT ARM</b> FOR CLOSER MODEL 603 & 693	ALUMINUM	14-R603AAL	10
		DURONODIC BRONZE	14-R603ADB	10
		BRASS (US3)	14-R603ABR	10
		WHITE	14-R603AWH	10
	<b>P-TYPE REPLACEMENT ARM</b> FOR CLOSER MODEL 602	ALUMINUM	14-R602PAL	10
		DURONODIC BRONZE	14-R602PDB	10
		BRASS (US3)	14-R602PBR	10
		WHITE	14-R602PWH	10
	<b>P-TYPE REPLACEMENT ARM</b> FOR CLOSER MODEL 603 & 693	ALUMINUM	14-R603PAL	10
		DURONODIC BRONZE	14-R603PDB	10
		BRASS (US3)	14-R603PBR	10
		WHITE	14-R603PWH	10

**Taymor®**

**ACCESSORIES**

**F O R D O O R C L O S E R S**

**6 0 0 & 6 9 0 S E R I E S**

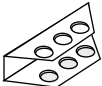
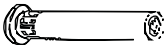
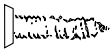
ILLUSTRATION	DESCRIPTION	FINISH	MODEL #	CASE QTY.
	<p><b>REGULAR ARM SHOE FOR ALL SIZE CLOSERS. SHOE ONLY. FOR 600 AND 690 SERIES.</b></p>	ALUMINUM	10-R636AL	10
		DURONODIC BRONZE	10-R636DB	10
		BRASS	10-R636BR	10
	<p><b>THROUGH BOLTS SLEEVE NUT SET. 4 PER SET. FOR 600 AND 690 SERIES.</b></p>	ALUMINUM	10-R1193AL	10
		DURONODIC BRONZE	10-R1193DB	10
		BRASS – BRONZE/GOLD	10-R1193BR	10
		POLISHED BRASS (US3)	13-TBLTBR	10
	<p><b>COMBINATION WOOD/MACHINE SCREWS FOR 600 AND 690 SERIES. 4 PER SET.</b></p>	ALUMINUM	10-R1199AL	10
		DURONODIC BRONZE	10-R1199DB	10
		BRASS – BRONZE/GOLD	10-R1199BR	10